

# LIQUID LEVEL DETECTOR

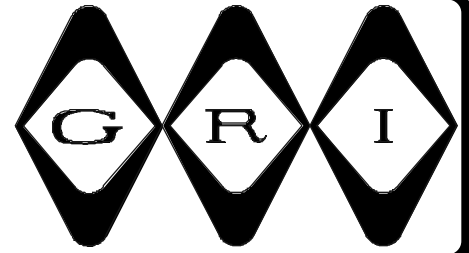

## 2826 & 2826FS

- ◆ Detects Non-Volatile Liquids
- ◆ For Use With Wireless Transmitters
- ◆ Microprocessor Controlled
- ◆ Installs Easily
- ◆ "C" Form Relay Contacts
- ◆ Fail Safe Version Available



2826



2826FS

### APPLICATION:

The G.R.I. 2826 Detector was designed in response to a direct request for a small electronic sensor capable of detecting non-volatile liquids in remote hard to reach locations. The sensor, in conjunction with your favorite wireless transmitter, can be used to detect and report the encroachment of non-volatile liquids into an isolated sensitive location.

The new 2826FS from GRI provides remote probes plus a **fail safe** capability. When the on board battery expends the last of its power, 3 to 5 years under normal conditions, the 2826FS automatically places itself in a **safe** mode to help prevent danger to devices, property and/or people. This safe mode keeps the zone assigned to the 2826FS in an alarm condition. This causes an authorized person or an alarm technician to physically inspect the 2826FS and replace the battery, prior to resetting and re-arming the system.

### DESCRIPTION:

The G.R.I. 2826 Detector is an internally powered, microprocessor controlled device that samples the conductivity between any two adjacent sensor points located on the bottom of the device. Power consumption is less than 1 micro-amp while in the standby mode. This allows for an extended duty cycle.

Relay contacts are latched in an open or closed position based on the conductivity measured between the sensors. External wire connections are provided to allow access to the "C" form relay contacts for output control of an external device.

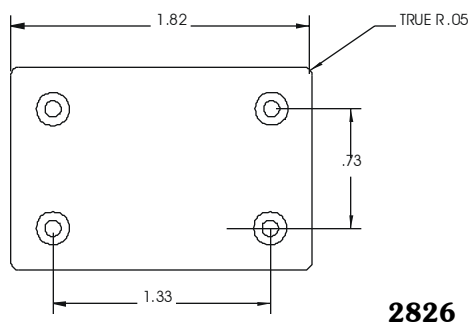

2826

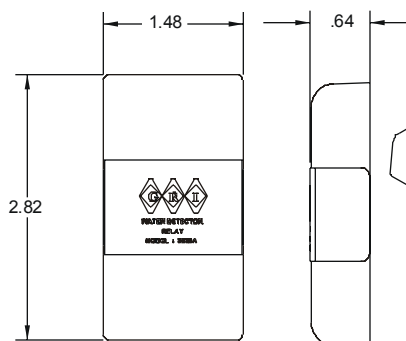
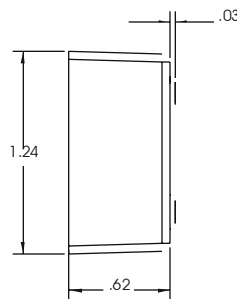

2826FS

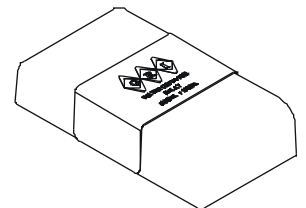

### WARRANTY:

One year warranty against workmanship, material and factory defects.

GEORGE RISK INDUSTRIES, INC.  
G.R.I. PLAZA  
KIMBALL, NE 69145



MADE IN U.S.A.

TOLL-FREE 1-800-445-5218  
TOLL-FREE 1-800-523-1227  
(308) 235-4645  
FAX (308) 235-3561

E-MAIL: [grisales@megavision.com](mailto:grisales@megavision.com)  
WEB SITE: [www.grisk.com](http://www.grisk.com)

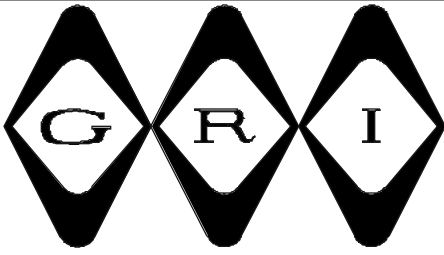

# LIQUID LEVEL DETECTOR

## 2826 Installation Instructions:

To install the G.R.I. 2826 Detector, place the unit where liquid is most likely to accumulate. Clean and dry the desired placement location. A smooth surface is preferable and preparing surface by using an alcohol wipe is recommended. Remove protective paper from double sided tape, then stick the unit to the cleaned surface.

To connect the 2826 Detector wires to an external device, see the installation instructions for that device.

Use the white and red wires for a closed loop circuit, or the white and black wires for an open loop circuit.

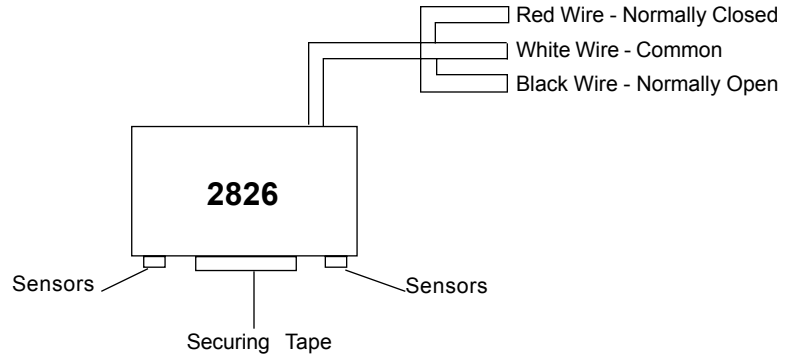

### SPECIFICATIONS:

Average Duty Cycle at Manufacture	Approximately 5 years
<b>Contact Rating</b>	
Nominal Switching Capacity	2A@30VDC
Max Switching Power	60W
Max Switching Voltage	220VDC
Max Switching Current	2A

## 2826FS Installation Instructions:

Mount the 2826FS Detector Relay on a wall no more than 100 feet from desired location to be monitored. Mount the sensor probes at locations where liquid pooling is most likely to occur. Run probe wires from sensor probes to the detector relay and connect wires to sensor terminals. Wire all sensor probes in **parallel**.

Use the relay contact terminals to connect to external devices such as wireless transmitters or connect directly to alarm or controller systems.

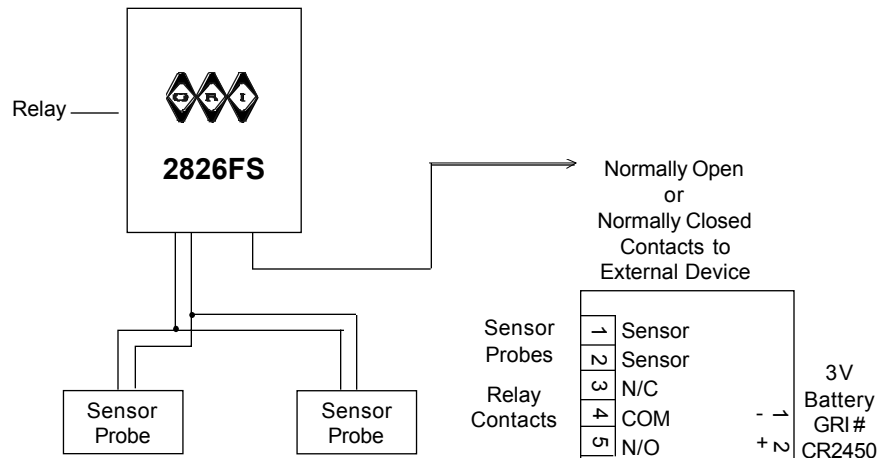

### SPECIFICATIONS:

Probe with 36" Leads	GRI # 2826-P
Battery with Connector	GRI # 8444
Battery Life	Approximately 4 years
<b>Contact Rating</b>	
Nominal Switching Capacity	2A@30VDC
Max Switching Power	60W
Max Switching Voltage	220VDC
Max Switching Current	2A
Max Number Sensor Probes	10
Max Wire Length for Detector to Probe	100 ft.

GEORGE RISK INDUSTRIES, INC.  
G.R.I. PLAZA  
KIMBALL, NE 69145



MADE IN U.S.A.

TOLL-FREE 1-800-445-5218  
TOLL-FREE 1-800-523-1227  
(308) 235-4645  
FAX (308) 235-3561  
E-MAIL: [grisales@megavision.com](mailto:grisales@megavision.com)  
WEB SITE: [www.grisk.com](http://www.grisk.com)